

Direct-Fired Heating & Ventilating

*Advanced Energy-Saving
Design Excellence*

Capacities to
17,000 MBH and
130,000 CFM



Pure and Simple Solutions

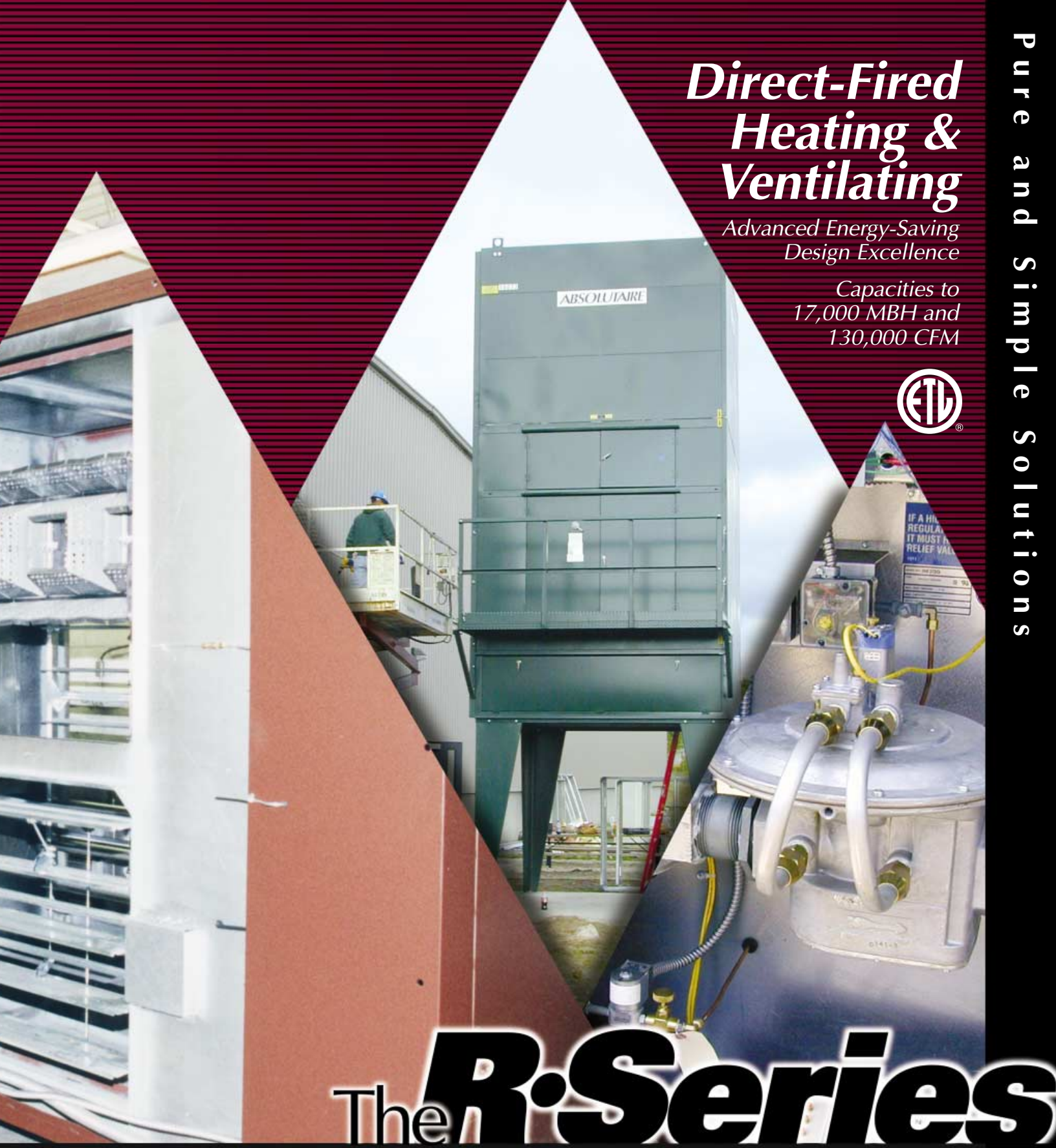

The **R-Series**



The R-Series

AbsolutAire's Direct-Fired Heating & Ventilating Solutions

Today's challenges for facility indoor-air-quality management are only surpassed by the growing need for environmentally friendly solutions that consistently deliver long-term operating efficiency.

R-Series, the heart and soul of AbsolutAire's extensive line of direct-gas-fired systems, is often "The Best Available Technology." Pure and Simple: R-Series has been an industry-leading design technology for many years ... and, the benchmark for innovation and excellence is moving the performance bar ever higher.

These advanced systems for make-up air and heating and ventilating are unmatched in design flexibility, application versatility, operating economy and construction integrity.

"Total Air Management" is at the center of the design strategy to optimize indoor air quality. By introducing a slight positive pressure to the space, R-Series helps to ensure occupant comfort and improved productivity by reducing heat stratification and cold air infiltration, while also displacing airborne odors, dust, dirt, and other contaminants.

AbsolutAire's R-Series is also an optimum choice for "green building" design and construction. Environmental friendliness starts with its use of natural gas — one of the most abundant, economical and cleanest burning fuels available. R-Series then makes the most of it with almost 100-percent combustion efficiency, reduced fan motor horsepower for lower electrical costs and a variety of

options for blending tempered indoor air with fresh outdoor air for even more savings.

R-Series offers an outstanding choice of models, with capacities up to 17,000 MBH and 130,000 CFM, and an attractive range of standard and optional features. Two styles of cabinet construction excellence are available. The horizontal and upright unit configurations provide installation flexibility. An exclusive Two-Year Parts and 90-Day Labor Limited Warranty stands behind our commitment to quality.

All AbsolutAire R-Series models are available with ETL Certification to current ANSI Design Standards.



R-Series Advantages

- ▲ Energy-Saving Design Excellence
 - 99.8% Efficient Burner
 - Up to 40% Less Motor Brake Horsepower (vs. DWDI Forward-Curved Fans)
 - 30:1 Turndown Capability
- ▲ The Best Available Technology
 - Two Styles of Construction Excellence
 - Advanced Components and Controls
 - Special Solutions for Special Challenges
- ▲ Multiple Sizes for Application Versatility
 - Airflow Capacities from 4,000 to 130,000 CFM
 - Heating Capacities from 200 to 17,000 MBH
 - Horizontal and Upright Systems Provide Low-Cost, Ductless Installation Flexibility
- ▲ An Absolute Commitment
 - Cutting-Edge Direct-Fired Technologies
 - Advanced Manufacturing, Superior Service
 - Exclusive Two-Year Parts and 90-Day Labor Limited Warranty
- ▲ ETL Certification to ANSI Design Standards:
 - ANSI Z83.18a-2001 for 85/15 Outside/Return Air Models
 - ANSI Z83.4a-2001 and CSA 3.7a 2001 for Constant 100% or Variable Outside Air Models
 - UL 1995 for Models with Fluid or Steam Coils



The Rest of the Story...

<i>Product Line Overview</i>	page 2
<i>R-Series Advantages</i>	3
<i>Total Air Management</i>	4
<i>Environmentally Friendly Economy</i>	5
<i>Complete Application Versatility</i>	6
<i>Superior Design Flexibility</i>	8
<i>Construction Highlights & Benefits</i>	10
<i>Model Selection & Performance</i>	12
<i>Gas Manifold Sizing & Selection</i>	14
<i>Controls & Special Solutions</i>	15
<i>Dimensional Data – Cabinets</i>	16
<i>Dimensional Data – Options & Accessories</i>	17
<i>General Specifications</i>	18
<i>Quality Control and Warranty Services</i>	19
<i>Features, Options, Accessories</i>	20
<i>Meeting & Exceeding Customer Expectations</i>	22

The R-Series

Total Air Management

Properly managing Indoor Air Quality (IAQ) calls for balancing optimum occupant comfort with facility heating and ventilating cost.

R-Series direct-gas-fired systems from AbsolutAire are among today's most advanced solutions for providing both occupant comfort and operating economy. They also provide easy installation, maintenance simplicity and long-term durability.

Both return-air and variable-volume models are available in a range of MBH and CFM capacities. All can be fueled with either natural gas or liquid propane (LP) gas. The air volume is sized to slightly pressurize the space, forcing out dust and dirt and

limiting cold-air infiltration. Various amounts of fresh outside air can be blended with tempered inside air with different damper arrangements.



Critical factors in making this "The Best Available Technology" include properly calculating the right Air-Turnover Rate and matching it with the right Supply Air Temperature. A proper air-turnover rate helps to maintain uniform space temperatures, while the correct tempered-air discharge (within 15° to 20°F of the desired space temperature) helps to eliminate heat stratification and reduce space heat loss. Achieving the right balance maximizes occupant comfort and facility IAQ.

In any comparison with indirect heating and ventilating systems, direct-gas-fired systems such as R-Series offer substantial benefits. Higher efficiencies mean lower operating costs. More uniform temperatures mean added occupant comfort. Improved IAQ means increased productivity. And, foul air, smoke and odors are pushed out, while cold air and airborne contaminants are not pulled in.

Pure and Simple:
R-Series delivers Total Comfort.

Direct Gas-Fired

- 99.8% energy efficient burner
- Uniform temperatures
- Improved IAQ = lower costs
- Slight pressure forces out smoke, odors, contaminants

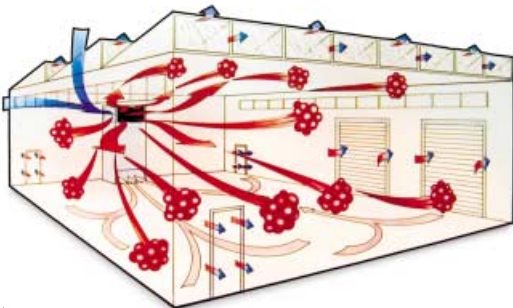

Indirect Gas-Fired

- Lower efficiency
- Heat stratification is common
- Poor IAQ = higher costs
- Outside air, dust, dirt infiltration

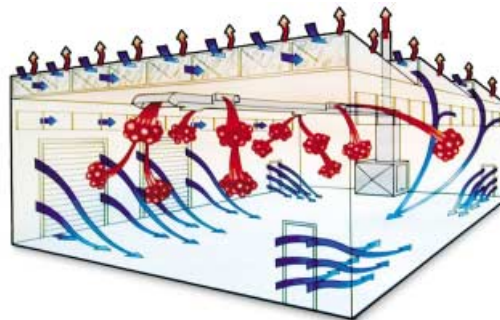

Environmentally Friendly Economy

Responsible facility air-quality managers today emphasize environmental friendliness and maximum energy efficiency.

R-Series direct-gas-fired systems from AbsolutAire are recognized as some of the best solutions available for “green building” design and construction. Some 19 R-Series units are installed and paying dividends on the very first manufacturing facility ever certified by the U.S. Green Buildings Council. This system, featuring humidification and precise microprocessor control, is capable of delivering up to 1.15 million CFM and 108,384 MBH.

R-Series airflow burners are virtually 100% efficient. Compared to indirect-fired systems with heat exchangers, fuel savings alone can amount to 20 to 25% with little or no loss of efficiency over time. The especially clean burn limits products of combustion to extremely low levels, well below allowable standards. R-Series is an environmentally responsible technology that offers significant operating economy.

Yet, extraordinary fuel savings are just part of the story. AbsolutAire equips its R-Series units with backward-inclined air-foil fans. Compared to the DWDI forward-curved fans typically used in the industry, our approach uses up to 40% less motor brake horsepower to deliver equal volumes of airflow. As a result, R-Series requires less electrical energy, offering considerable savings for first-cost pay-back.

Other savings come from the design strategy. Modular construction allows matching application specifics without customized equipment. Return Air models conserve energy while maintaining high levels of comfort. Reduced heat stratification and infiltration minimize heat losses. Discharge choices eliminate ductwork and reduce installation time and costs.

Pure and Simple:
R-Series delivers True Economy.

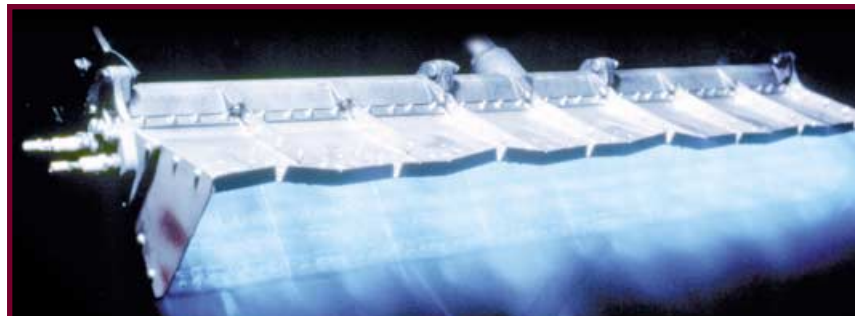

*Photo courtesy of
Steelcase, Inc.
Grand Rapids, MI.*

The R-Series

Complete Application Versatility

R-Series direct-gas-fired systems offer a wide range of facility air management choices, as well as maximum installation flexibility. From the low-first-cost R300 models to the robust R400 models, AbsolutAire delivers cutting-edge, state-of-the-art solutions.

Heating capacities range from 200 to 17,000 MBH, and ventilating capacities from 4,000 to 130,000 CFM. Various R-Series models suit specific application needs. And, all are available ETL Certified to the latest ANSI Design Standards.



Return Air Models

Three variations of R-Series return air models are available. Each is designed to operate with a minimum of 15% Outside Air (OA), while a corresponding amount of Building Air is re-circulated (RA).

"M" Option — These units are capable of modulating between 15% and 100% OA, and 85% to 0% RA. R-Series M-Option modulating models are commonly used for heating and ventilating applications. They provide a simple method for controlling building infiltration through the H & V equipment. The system reacts quickly by providing more outside air to the space when building doors are opened and closed or exhaust fans are cycled on and off.

"B" Option — These units are two-position OA/RA designs that can be in either a 100% OA operating mode or in a 15% OA – 85% RA mode. Different OA/RA blends are available (e.g., 50-50, 80-20, and so on). R-Series B-Option models are commonly used when total make-up air is needed during certain periods and minimal outside air is needed the rest of the time.

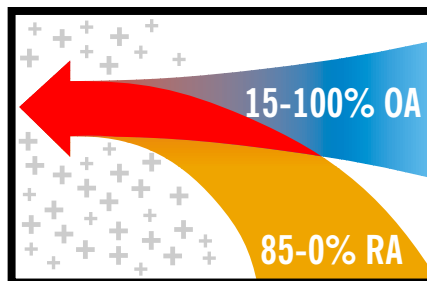
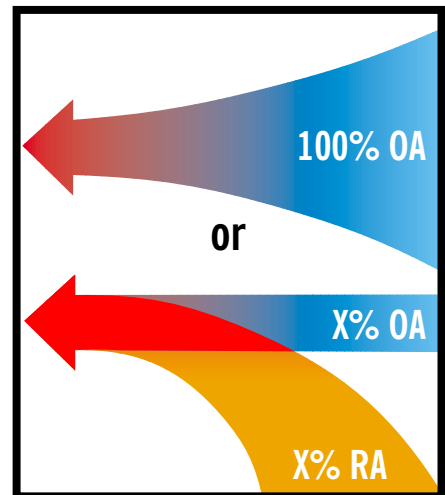

“F” Option — These units are designed for space heating only, with full-time air turnover. A two-position damper is on the outside air inlet only, and the return air opening is fixed. The common air-mixing ratio is 15% OA to 85% RA, but other ratios are available. R-Series F-Option models are usually selected for applications requiring minimum ventilation but maximum heating efficiency.

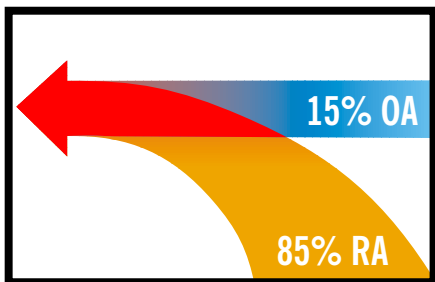

Variable Volume Models

When 100% outside air is needed, Variable Volume (“V” Option) units add a significant capability for precisely controlling the Supply Air (SA) discharged into the space. SA volume can usually be reduced to a minimum of 35%, using two-speed motors, variable frequency drives (VFDs) or motorized dampers.

R-Series V-Option models are commonly used in paint booths, wastewater treatment plants and other applications in which recirculation of building or space air is not desirable. Another common application is “pressure-controlled space heating.” Energy costs can be minimized with the variable air volumes and a burner turndown of up to 30 to 1. These models include a profile damper with a differential pressure switch, which maintains the correct air velocity across the burner profile opening.

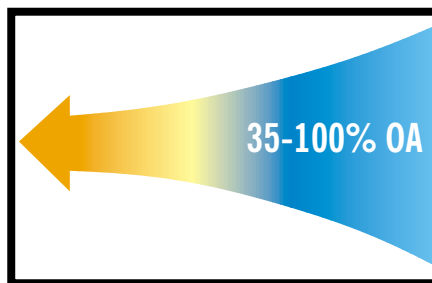

Maximum Installation Flexibility

R-Series direct-gas-fired systems, horizontal or upright units, provide maximum installation flexibility. AbsolutAire’s plenum fan arrangement, modular design and construction integrity allow up to five different Supply Air (SA) discharge choices. Without the need for (or expense of) lengthy ductwork runs, R-Series Total Air Management through space pressurization also opens up numerous options for where the units are installed on a facility. The exceptional operating efficiencies are never compromised.

Supply Air (SA) Discharge Choices

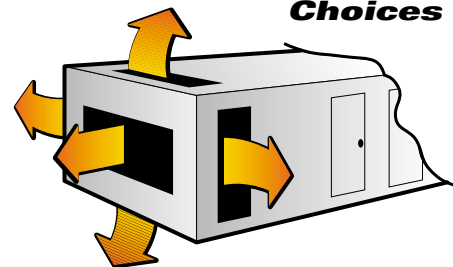

The R-Series

Superior Design Flexibility

R-Series direct-gas-fired systems for make-up air and heating and ventilating offer one of the industry's widest selections of both standard and optional features. Pure and Simple: AbsolutAire can deliver superior design flexibility, with system configurations and advanced components matched to exact facility requirements.



Standard Features

- ▲ Project-Matched, “Best Available Technology”
- ▲ Horizontal or Upright Cabinets
- ▲ Multiple Discharge Configurations
- ▲ Pitched Roofs (Away from Control Side)
- ▲ Rigid Construction with Structural Steel Frame Members (2” Tubular Steel Frame System on R400 Models)
- ▲ Weather-Resistant, Heavy-Gauge Aluminized Steel Construction (Fully Welded 16-gauge on R300 Models; Standing Seam 18-gauge on R400 Models)
- ▲ Double-Wall Service-Area Floors (R400 models)
- ▲ Multiple Hinged-Access Doors (Double-Wall with Full-Length Stainless Steel Piano Hinges on R400 Models)
- ▲ Durable Two-Coat Machine-Enamel Paint Finish (Owner-Matched Colors at No Extra Cost)
- ▲ Thermal-Overload Protection on Fan Motor Starters
- ▲ Non-Overloading, Backward-Inclined Airfoil fan
- ▲ Spherical Roller Bearings(L10 Minimum Life 100,000 Hours)
- ▲ Extended Lube Lines for Fan Bearings
- ▲ EPACT-Compliant ODP Fan Motors
- ▲ Direct-Drive, Shaft-Coupled Motorized Damper Actuators
- ▲ Recessed, Ventilated and Lighted Control Enclosures (Electrical and Gas)
- ▲ Maxitrol Discharge Temperature Controls (Series 14 on 100% Outside Air Models, Series 44 on “F” Models)
- ▲ Maxitrol Series DFM Digital Space Temperature Controls (Standard on “M” and “B” Return Air Models)
- ▲ Circuit Analyzer Lights in Main and Remote Control Panels
- ▲ 24/120-Volt Interconnect (Remote) Wiring
- ▲ 100% Efficient Burner with Interrupted Pilot
- ▲ Fixed Burner Profiles (Up to 30:1 Turndown Capability)
- ▲ Solid-State Flame Safeguard System
- ▲ U.V. Scanner and Remote Flame Reset
- ▲ High- and Low-Limit Temperature Controls
- ▲ High- and Low-Limit Airflow Switches
- ▲ Through-Door Fused Disconnect
- ▲ ETL Certification to ANSI Design Standards
- ▲ 100% Factory Testing (More Than 100 Quality Checks)
- ▲ Two-Year Parts and 90-Day Labor Limited Warranty

Optional Features

- ▲ Legs or Plenum Bases for Upright Models
- ▲ Inlet Hoods with Bird Screen or 2” Aluminum Filters
- ▲ Motorized Inlet or Discharge Dampers
- ▲ Insulated Cabinets (1” on R300 Models; 1” or 2” on R400 Models)
- ▲ Double-Wall Construction (1” on R300 models, 2” on R400 Models)
- ▲ Access Door Interlock
- ▲ Multiple Filtering Choices (OA or OA/RA)
- ▲ Clogged Filter Light/Alarm
- ▲ Splash Plate (Economical for Air Diffusion)
- ▲ Discharge Diffusers (1-, 3- or 4-Way) with Single- or Double-Deflection for Airflow Control
- ▲ Roof Curb, Flat or Pitched (Shipped Knocked Down)
- ▲ Service Platforms (OSHA-Compliant)
- ▲ Louvered Plenums for Horizontal Models
- ▲ 120-Volt GFI Outlet and Light
- ▲ TEFC Fan Motors, High-Efficiency and Automotive-Spec Options
- ▲ Motor Phase-Loss Protection
- ▲ Motor Belt Guards
- ▲ Vibration Isolation (External)
- ▲ Exhaust Cycle (Most Models)
- ▲ Evaporative Cooling Packages
- ▲ Cooling Sections with Chilled Water or DX Coils
- ▲ Heating Sections with Hot Water, Steam or Electric Coils
- ▲ Space Temperature Controls for 100% OA Models
- ▲ DDC Microprocessor Controls
- ▲ Mild Weather Stat
- ▲ Burner Alarm Horn
- ▲ Purge Timer (30-Seconds)
- ▲ Three-Phase Power Monitor
- ▲ Smoke Detector
- ▲ Magnahelic and Photohelic Gauges
- ▲ FM or IRI Gas Manifold
- ▲ Natural Gas-to-Propane (LP) Changeover Switch
- ▲ High Gas-Pressure Regulator
- ▲ Low Gas-Pressure Burner Assembly (at No Additional Cost)

The R-Series

Construction Highlights & Benefits

The Basis of Design: R300 Models

AbsolutAire's R300 models set the standard of excellence for direct-gas-fired heating and ventilating systems. As the basis of design for the entire R-Series line, R300 models blend optimum functionality and reliability with a low first cost. Some of the key construction features and user benefits are highlighted here.

Rigid Structural Steel Frame

Mill-primed with grey oxide for strength, integrity, long life; includes fan, bearing and motor structural steel supports

Durable, Heavy-Gauge Exterior Walls

Weather-resistant exterior skin; completely welded 16-gauge aluminized steel

Choice of Exterior Colors

Durable two-coat machine-enamel finishes; dark green standard; owner-matched colors at no additional cost

Backward-Inclined Airfoil Fan*

Non-overloading SWSI plenum fan, requiring up to 40% less brake horsepower for quiet, efficient, economical operation

Spherical Roller Bearings*

L10 minimum life 100,000 hours; extended lube lines enhance serviceability

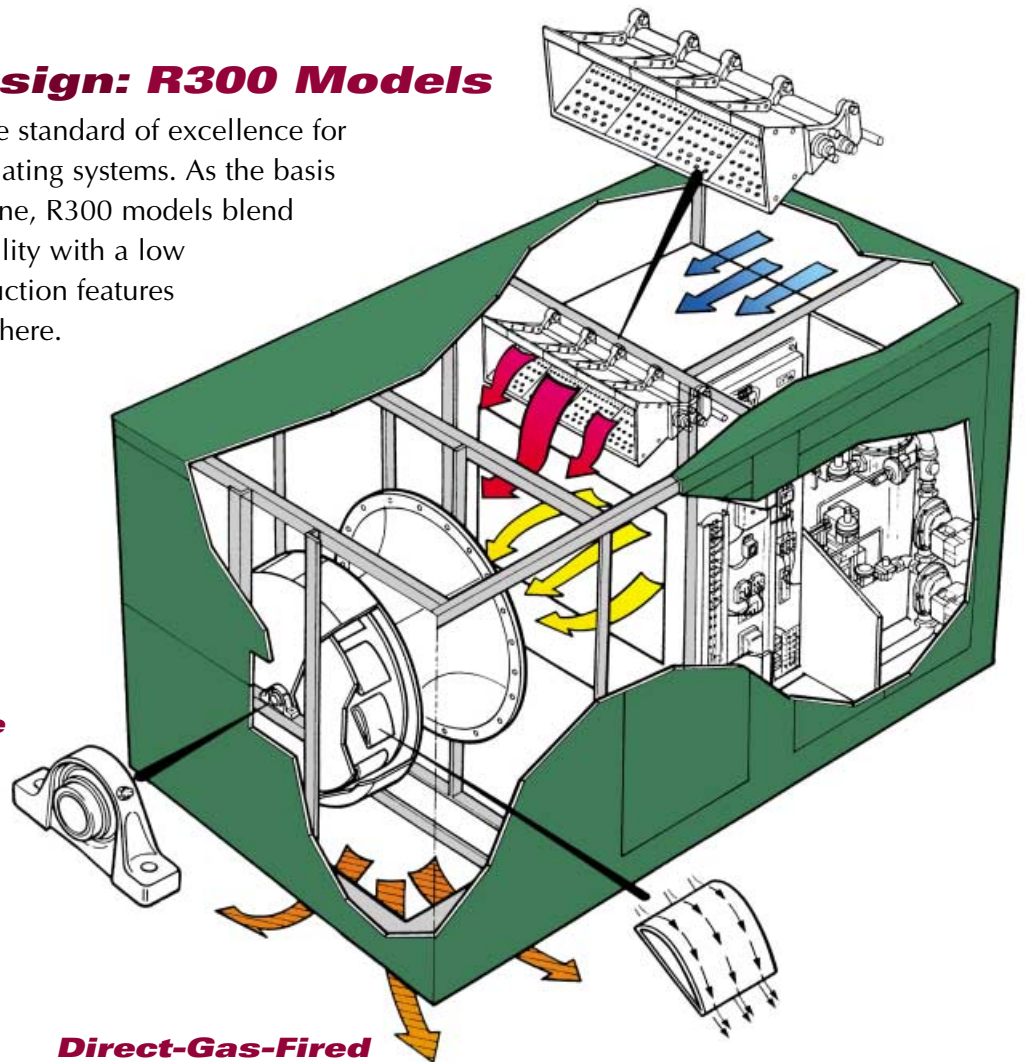

Direct-Gas-Fired Burner Systems*

Pre-mix solid-state burners for low emissions, high efficiency; cast iron standard, cast aluminum optional; 30:1 turndown capability

Flame Safeguard System*

Solid-state electronic system utilizes a U.V. scanner for failsafe combustion monitoring and reliability; includes remote flame reset

Advanced Gas & Electrical Controls*

Recessed control enclosures with hinged access doors; include control enclosure service lights

Low-Energy Fan Motors*

Lower BHP required for specified airflow volumes due to airfoil plenum fan; rugged belt drives; thermal-overload protection

*Common On R300 and R400 Models.

The Best of Design: R400 Models

AbsolutAire's R400 models set a new benchmark for premium design and construction in direct-gas-fired heating and ventilating systems. While retaining the operating performance and economical efficiency of the R-Series brand, an innovative cabinetry design delivers a host of new user benefits. Some of these are highlighted here.

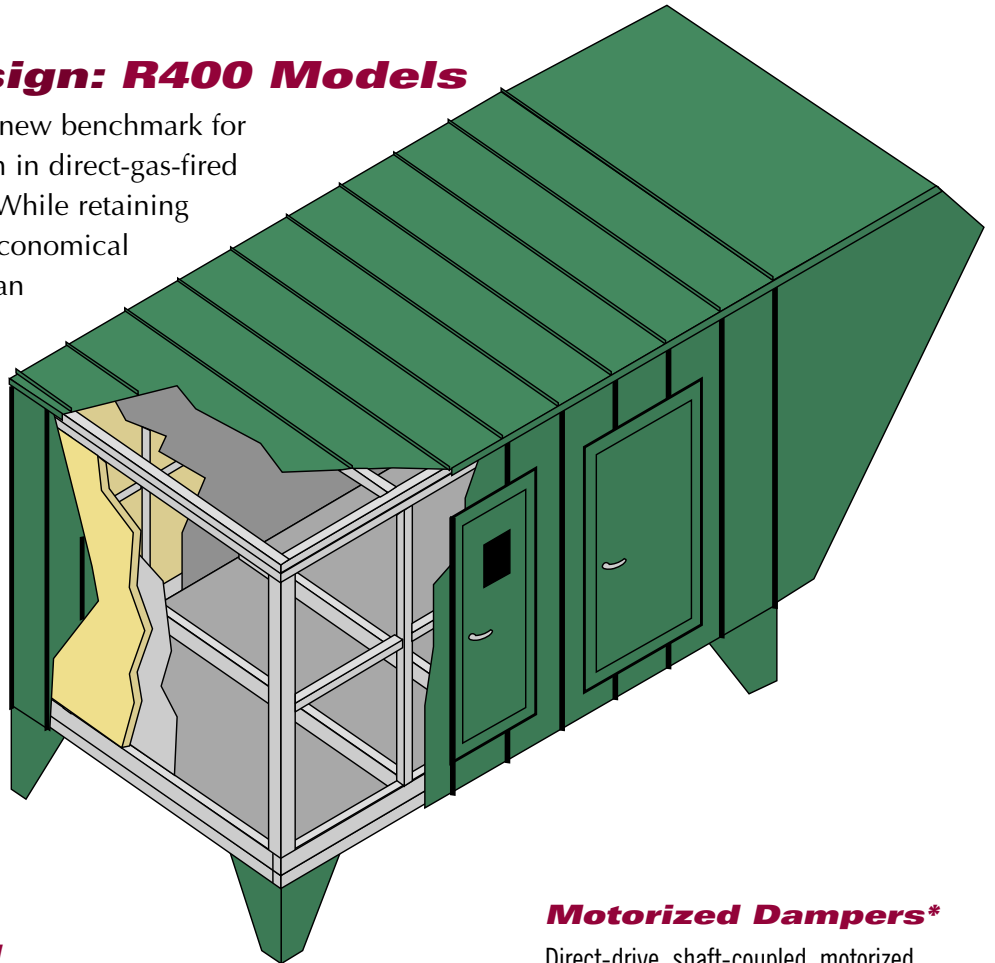

Tubular Steel Framing

Robust two-inch tubular steel cabinet framing members with built-in thermal breaks and two-inch insulation available

Standing-Seam Exterior Walls

Heavy-gauge aluminized steel; standing seam construction adds aesthetics; choice of paint finishes and colors

Unique Section-Locking System

For quicker and more precise in-field installation of operating sections on larger units

Double-Wall Doors

Insulated, with positive latching mechanisms, full-length stainless-steel piano hinges and an aluminum-extrusion frame

Double-Wall Floors

Exceptional strength and durability in service areas for operating components (burner, motor and fan)

Pitched Roofs*

Standing-seam roofs are pitched away from the control side. (No standing seam on R300 models.)

Motorized Dampers*

Direct-drive, shaft-coupled, motorized damper actuators are standard on all motorized inlet, return-air and discharge dampers

Industry-Leading Return Air Models*

Return air models circulate a minimum of 15% fresh outside air; variable volume (100% OA) models available

Discharge Diffuser Choices*

All models can be built with 1-, 3- or 4-way discharge diffusers with single- or double deflection for airflow control

*Common On R300 and R400 Models.

The R-Series

Model Selection and Performance

Table 1: Static Pressure Drops for Base Cabinets¹

	Horizontal Models Inches W.C.	Upright Models Inches W.C.
O or V (100% OA)	0.90	0.95
M (85/15 Modulating) ²	1.05	1.10
B (85/15 Two-Position) ²	0.95	1.00
F (85/15 Fixed Air Rotation) ²	0.95	1.00

Table 2: Static Pressure Drops for Options/Accessories

Description	Inches W.C.
Inlet Hood with Birdscreen	0.05
Louvered Inlet Plenum	0.13
Inlet Plenum Base	0.06
Filtered Inlet Hood (Includes 2" Aluminum Mesh Filters) ³	0.10
Motorized Inlet Damper	0.10
Motorized Discharge Damper	0.15
3-Way Single-Deflection Diffuser (Horiz. Blades)	0.20
3-Way Double-Deflection Diffuser (Horiz. and Vert. Blades)	0.25
4-Way Single-Deflection Diffuser (Horiz. Blades)	0.20
4-Way Double-Deflection Diffuser (Horiz. and Vert. Blades)	0.25
Discharge Plenum	0.10
Side Access Filter Section (2" 30% Pleated) ³	0.30
Side Access Filter Section (2" Aluminum Mesh) ³	0.15
Side Access Filter Section (1.5" Dust-Lock) ³	0.20
Filter/Mix Box (2" 30% Pleated) ³	0.30
Filter/Mix Box (2" Aluminum Mesh) ³	0.15
Filter/Mix Box (1.5" Dust-Lock) ³	0.15
Evaporative Cooling Section (with 6" Thick Media)	0.15
Evaporative Cooling Section (with 12" Thick Media)	0.30
Typical CW or DX Coil Box ⁴	0.60 – 0.90
Typical Steam or HW Coil Box ⁴	0.30 – 0.40

Table 3: Static Pressure Drops for Discharge Configurations

Description	Inches W.C.
Axial Discharge (with 3-feet of Straight Duct Minimum)	0.15
Axial Discharge (without a Plenum or 3-feet Straight Duct)	0.20
Radial Discharge (without a Plenum or 3-feet Straight Duct)	0.10

NOTES:

1. Base cabinet static pressure drops are calculated using 25°F entering air temperature and 90°F exiting air temperature. They are also calculated using a radial discharge (side, up or down) with at least 3-feet of straight duct. Static pressure drops for filter sections, inlet hoods and other options and accessories must be added.
2. Includes static pressure drops for dampers.
3. This includes the initial static pressure drop of "clean" filters.
4. Consult factory for exact coil losses in your application.

Important: On units with a filter option, the filters should be changed when the filter pressure drop reaches 0.60" w.c. Consult factory for change recommendations on high-efficiency filtering options.

Total Static Pressure Drop: After adding the losses from the base cabinet and options/accessories, also add project-specific ductwork losses. These are typically found in the owner specification.

Maximum MBH Capacities¹

Model	100% OA Models ²		Return Air Models ³	
	Natural Gas	LP Gas	Natural Gas	LP Gas
R318	795	635	665	610
R320	1,060	850	885	810
R327 - R427	1,720	1,380	1,440	1,320
R330 - R430	2,250	1,805	1,885	1,725
R336 - R436	2,915	2,335	2,440	2,235
R340 - R440	3,975	3,190	3,325	3,050
R344 - R444	4,640	3,720	3,880	3,555
R349 - R449	5,305	4,250	4,435	4,065
R354 - R454	6,630	5,315	5,545	5,080
R360 - R460	7,955	6,380	6,655	6,100
R366 - R466	9,945	7,975	8,315	7,625
R373 - R473	11,270	9,035	9,425	8,640
R380 - R480	13,925	10,635	11,645	10,165
R389 - R489	17,240	12,760	14,420	12,200

NOTES:

1. Maximum MBH Capacities listed are based on a unit operating at 750-foot elevation and an outside air (OA) temperature of - 10°F.
2. On 100% Outside Air (OA) models, selections are limited to the lesser of the Maximum MBH shown or a temperature rise of 125°F for natural gas or 95°F for propane (LP) gas.
3. On Return Air (RA) models, selections are limited to the lesser of the Maximum MBH shown or a temperature rise of 100°F for natural gas or 90°F for propane (LP) gas.

Model Selection, Fan and Motor Requirements

Unit CFM	Model	Motor and Fan Requirements @ Total Static Pressure Shown																Outlet Velocity ² (FPM)
		1.25"		1.50"		1.75"		2.00"		2.50"		3.00"		3.50"		4.00"		
		HP	BHP	HP	BHP	HP	BHP	HP	BHP	HP	BHP	HP	BHP	HP	BHP	HP	BHP	
4,000	R318	2	1.39	2	1.60	2	1.81	3	2.02	3	2.46	3	2.93	5	3.41	5	3.91	1,058
6,000		3	2.73	3	3.00	5	3.30	5	3.60	5	4.20	5	4.81	<u>7.5</u>	<u>5.43</u>	<u>7.5</u>	<u>6.06</u>	1,588
6,000	R320	3	2.35	3	2.65	3	2.95	5	3.25	5	3.87	5	4.51	<u>7.5</u>	<u>5.16</u>	<u>7.5</u>	<u>5.82</u>	1,588
8,000		5	3.99	5	4.38	5	4.76	<u>7.5</u>	<u>5.14</u>	<u>7.5</u>	<u>5.93</u>	<u>7.5</u>	<u>6.72</u>	<u>7.5</u>	<u>7.50</u>	<u>10</u>	<u>8.35</u>	2,117
7,000	R327	2	2.00	3	2.38	3	2.76	5	3.15	NA	NA	NA	NA	NA	NA	NA	NA	955
10,000	R427	5	3.28	5	3.75	5	4.22	5	4.70	<u>7.5</u>	<u>5.69</u>	<u>7.5</u>	<u>6.71</u>	<u>10</u>	<u>7.78</u>	<u>10</u>	<u>8.88</u>	1,364
13,000		<u>7.5</u>	<u>5.11</u>	<u>7.5</u>	<u>5.69</u>	<u>7.5</u>	<u>6.28</u>	<u>7.5</u>	<u>6.87</u>	<u>10</u>	<u>8.07</u>	<u>10</u>	<u>9.29</u>	<u>15</u>	<u>10.54</u>	<u>15</u>	<u>11.82</u>	1,773
13,000	R330	5	4.38	5	4.98	<u>7.5</u>	<u>5.59</u>	<u>7.5</u>	<u>6.20</u>	<u>7.5</u>	<u>7.46</u>	<u>10</u>	<u>8.76</u>	<u>15</u>	<u>10.10</u>	<u>15</u>	<u>11.51</u>	1,156
15,000		R430	<u>7.5</u>	<u>5.57</u>	<u>7.5</u>	<u>6.25</u>	<u>7.5</u>	<u>6.93</u>	<u>10</u>	<u>7.62</u>	<u>10</u>	<u>9.02</u>	<u>15</u>	<u>10.46</u>	<u>15</u>	<u>11.93</u>	<u>15</u>	<u>13.42</u>
17,000	R336	<u>7.5</u>	<u>7.00</u>	<u>10</u>	<u>7.76</u>	<u>10</u>	<u>8.52</u>	<u>10</u>	<u>9.28</u>	<u>15</u>	<u>10.84</u>	<u>15</u>	<u>12.42</u>	<u>15</u>	<u>14.02</u>	<u>20</u>	<u>15.61</u>	1,511
17,000		R436	<u>7.5</u>	<u>5.51</u>	<u>7.5</u>	<u>6.28</u>	<u>7.5</u>	<u>7.07</u>	<u>10</u>	<u>7.87</u>	<u>10</u>	<u>9.58</u>	<u>15</u>	<u>11.36</u>	<u>15</u>	<u>13.20</u>	<u>20</u>	<u>15.11</u>
19,500	R336	<u>7.5</u>	<u>6.95</u>	<u>10</u>	<u>7.78</u>	<u>10</u>	<u>8.64</u>	<u>10</u>	<u>9.52</u>	<u>15</u>	<u>11.32</u>	<u>15</u>	<u>13.26</u>	<u>20</u>	<u>15.26</u>	<u>20</u>	<u>17.31</u>	1,733
22,000		R436	<u>10</u>	<u>8.73</u>	<u>10</u>	<u>9.60</u>	<u>15</u>	<u>10.53</u>	<u>15</u>	<u>11.48</u>	<u>15</u>	<u>13.45</u>	<u>20</u>	<u>15.50</u>	<u>20</u>	<u>17.59</u>	<u>20</u>	<u>19.80</u>
22,000	R340	8	7.40	<u>10</u>	<u>8.37</u>	<u>10</u>	<u>9.37</u>	<u>15</u>	<u>10.39</u>	<u>15</u>	<u>12.52</u>	<u>15</u>	<u>14.76</u>	<u>20</u>	<u>17.03</u>	<u>20</u>	<u>19.42</u>	1,460
26,000		R440	<u>10</u>	<u>10.00</u>	<u>15</u>	<u>11.07</u>	<u>15</u>	<u>12.18</u>	<u>15</u>	<u>13.31</u>	<u>20</u>	<u>15.66</u>	<u>20</u>	<u>18.11</u>	<u>25</u>	<u>20.63</u>	<u>25</u>	<u>23.27</u>
30,000	R344	<u>15</u>	<u>13.40</u>	<u>15</u>	<u>14.56</u>	<u>20</u>	<u>15.70</u>	<u>20</u>	<u>16.96</u>	<u>20</u>	<u>19.54</u>	<u>25</u>	<u>22.20</u>	<u>25</u>	<u>24.95</u>	<u>30</u>	<u>27.79</u>	1,991
30,000		R444	<u>15</u>	<u>10.94</u>	<u>15</u>	<u>12.21</u>	<u>15</u>	<u>13.52</u>	<u>15</u>	<u>14.85</u>	<u>20</u>	<u>17.63</u>	<u>25</u>	<u>20.50</u>	<u>25</u>	<u>23.52</u>	<u>30</u>	<u>26.63</u>
32,500	R344	<u>15</u>	<u>12.78</u>	<u>15</u>	<u>14.06</u>	<u>20</u>	<u>15.44</u>	<u>20</u>	<u>16.85</u>	<u>20</u>	<u>19.76</u>	<u>25</u>	<u>22.79</u>	<u>30</u>	<u>25.89</u>	<u>30</u>	<u>29.16</u>	1,625
35,000		R444	<u>15</u>	<u>14.83</u>	<u>20</u>	<u>16.22</u>	<u>20</u>	<u>17.59</u>	<u>20</u>	<u>19.08</u>	<u>25</u>	<u>22.12</u>	<u>30</u>	<u>25.21</u>	<u>30</u>	<u>28.56</u>	<u>40</u>	<u>31.89</u>
35,000	R349	<u>15</u>	<u>12.36</u>	<u>15</u>	<u>13.86</u>	<u>20</u>	<u>15.40</u>	<u>20</u>	<u>16.98</u>	<u>25</u>	<u>20.20</u>	<u>25</u>	<u>23.69</u>	<u>30</u>	<u>27.27</u>	<u>40</u>	<u>30.95</u>	1,750
37,500		R449	<u>15</u>	<u>14.01</u>	<u>20</u>	<u>15.59</u>	<u>20</u>	<u>17.20</u>	<u>20</u>	<u>18.85</u>	<u>25</u>	<u>22.27</u>	<u>30</u>	<u>25.78</u>	<u>30</u>	<u>29.53</u>	<u>40</u>	<u>33.36</u>
40,000	R354	<u>20</u>	<u>15.99</u>	<u>20</u>	<u>17.48</u>	<u>20</u>	<u>19.19</u>	<u>25</u>	<u>20.91</u>	<u>25</u>	<u>24.46</u>	<u>30</u>	<u>28.17</u>	<u>40</u>	<u>31.95</u>	<u>40</u>	<u>35.95</u>	2,000
40,000		R454	<u>15</u>	<u>13.39</u>	<u>20</u>	<u>15.15</u>	<u>20</u>	<u>16.95</u>	<u>20</u>	<u>18.82</u>	<u>25</u>	<u>22.67</u>	<u>30</u>	<u>26.74</u>	<u>40</u>	<u>30.94</u>	<u>40</u>	<u>35.28</u>
45,000	R360	<u>20</u>	<u>16.48</u>	<u>20</u>	<u>18.39</u>	<u>25</u>	<u>20.33</u>	<u>25</u>	<u>22.33</u>	<u>30</u>	<u>26.47</u>	<u>40</u>	<u>30.74</u>	<u>40</u>	<u>35.27</u>	<u>40</u>	<u>39.90</u>	1,761
50,000		R460	<u>25</u>	<u>20.28</u>	<u>25</u>	<u>22.20</u>	<u>25</u>	<u>24.31</u>	<u>30</u>	<u>26.45</u>	<u>40</u>	<u>30.86</u>	<u>40</u>	<u>35.45</u>	<u>50</u>	<u>40.10</u>	<u>50</u>	<u>45.07</u>
50,000	R360	<u>20</u>	<u>16.97</u>	<u>20</u>	<u>19.15</u>	<u>25</u>	<u>21.39</u>	<u>25</u>	<u>23.69</u>	<u>30</u>	<u>28.44</u>	<u>40</u>	<u>33.49</u>	<u>40</u>	<u>38.70</u>	<u>50</u>	<u>44.07</u>	1,744
55,000		R460	<u>25</u>	<u>20.11</u>	<u>25</u>	<u>22.43</u>	<u>25</u>	<u>24.81</u>	<u>30</u>	<u>27.25</u>	<u>40</u>	<u>32.31</u>	<u>49</u>	<u>37.53</u>	<u>50</u>	<u>43.06</u>	<u>50</u>	<u>48.73</u>
60,000	R366	<u>25</u>	<u>23.85</u>	<u>30</u>	<u>26.19</u>	<u>30</u>	<u>28.72</u>	<u>40</u>	<u>31.30</u>	<u>40</u>	<u>36.63</u>	<u>50</u>	<u>42.18</u>	<u>50</u>	<u>47.84</u>	<u>60</u>	<u>53.84</u>	2,092
60,000		R466	<u>25</u>	<u>20.22</u>	<u>25</u>	<u>22.83</u>	<u>30</u>	<u>25.53</u>	<u>30</u>	<u>28.31</u>	<u>40</u>	<u>34.04</u>	<u>50</u>	<u>40.10</u>	<u>50</u>	<u>46.37</u>	<u>60</u>	<u>52.85</u>
65,000	R366	<u>25</u>	<u>23.38</u>	<u>30</u>	<u>26.04</u>	<u>30</u>	<u>28.87</u>	<u>40</u>	<u>31.78</u>	<u>40</u>	<u>37.82</u>	<u>50</u>	<u>44.08</u>	<u>60</u>	<u>50.67</u>	<u>60</u>	<u>57.93</u>	1,791
70,000		R466	<u>30</u>	<u>26.84</u>	<u>30</u>	<u>29.63</u>	<u>40</u>	<u>32.61</u>	<u>40</u>	<u>35.66</u>	<u>50</u>	<u>41.97</u>	<u>50</u>	<u>48.54</u>	<u>60</u>	<u>55.31</u>	<u>75</u>	<u>62.39</u>
75,000	R373	<u>40</u>	<u>30.78</u>	<u>40</u>	<u>33.62</u>	<u>40</u>	<u>36.76</u>	<u>40</u>	<u>39.96</u>	<u>50</u>	<u>46.52</u>	<u>60</u>	<u>53.38</u>	<u>75</u>	<u>60.28</u>	<u>75</u>	<u>67.71</u>	2,067
75,000		R473	<u>30</u>	<u>25.64</u>	<u>30</u>	<u>28.88</u>	<u>40</u>	<u>32.22</u>	<u>40</u>	<u>35.66</u>	<u>50</u>	<u>42.73</u>	<u>60</u>	<u>50.26</u>	<u>60</u>	<u>58.02</u>	<u>75</u>	<u>66.01</u>
80,000	R380	<u>30</u>	<u>28.76</u>	<u>40</u>	<u>32.15</u>	<u>40</u>	<u>35.63</u>	<u>40</u>	<u>39.20</u>	<u>50</u>	<u>46.61</u>	<u>60</u>	<u>54.29</u>	<u>75</u>	<u>62.37</u>	<u>75</u>	<u>70.68</u>	1,976
85,000		R473	<u>40</u>	<u>32.18</u>	<u>40</u>	<u>35.74</u>	<u>40</u>	<u>39.36</u>	<u>50</u>	<u>43.07</u>	<u>60</u>	<u>50.75</u>	<u>60</u>	<u>58.57</u>	<u>75</u>	<u>67.01</u>	<u>100</u>	<u>75.63</u>
85,000	R380	<u>30</u>	<u>27.54</u>	<u>40</u>	<u>31.31</u>	<u>40</u>	<u>35.22</u>	<u>40</u>	<u>39.12</u>	<u>50</u>	<u>47.66</u>	<u>60</u>	<u>56.37</u>	<u>75</u>	<u>65.47</u>	<u>75</u>	<u>74.89</u>	1,702
92,500		R480	<u>40</u>	<u>31.78</u>	<u>40</u>	<u>35.77</u>	<u>40</u>	<u>38.87</u>	<u>50</u>	<u>44.09</u>	<u>60</u>	<u>52.76</u>	<u>75</u>	<u>62.03</u>	<u>75</u>	<u>71.57</u>	<u>100</u>	<u>81.35</u>
100,000	R389	<u>40</u>	<u>36.56</u>	<u>50</u>	<u>40.78</u>	<u>50</u>	<u>45.09</u>	<u>50</u>	<u>49.52</u>	<u>60</u>	<u>58.70</u>	<u>75</u>	<u>68.17</u>	<u>100</u>	<u>78.20</u>	<u>100</u>	<u>88.49</u>	2,002
105,000 ¹		R489	<u>50</u>	<u>40.26</u>	<u>50</u>	<u>44.44</u>	<u>50</u>	<u>48.91</u>	<u>60</u>	<u>53.47</u>	<u>75</u>	<u>62.92</u>	<u>75</u>	<u>72.77</u>	<u>100</u>	<u>82.90</u>	<u>100</u>	<u>93.52</u>
95,000	R389	<u>30</u>	<u>29.30</u>	<u>40</u>	<u>33.66</u>	<u>40</u>	<u>38.08</u>	<u>50</u>	<u>42.81</u>	<u>60</u>	<u>52.55</u>	<u>75</u>	<u>62.72</u>	<u>75</u>	<u>73.71</u>	<u>100</u>	<u>84.29</u>	1,589
110,000		R489	<u>40</u>	<u>37.17</u>	<u>50</u>	<u>41.95</u>	<u>50</u>	<u>46.86</u>	<u>60</u>	<u>51.93</u>	<u>75</u>	<u>62.38</u>	<u>75</u>	<u>73.47</u>	<u>100</u>	<u>84.92</u>	<u>100</u>	<u>96.73</u>
120,000	R389	<u>50</u>	<u>43.39</u>	<u>50</u>	<u>48.40</u>	<u>60</u>	<u>53.66</u>	<u>60</u>	<u>59.00</u>	<u>75</u>	<u>70.07</u>	<u>100</u>	<u>81.52</u>	<u>100</u>	<u>93.60</u>	<u>125</u>	<u>106.01</u>	2,007
130,000 ²		R489	<u>60</u>	<u>50.72</u>	<u>60</u>	<u>55.83</u>	<u>75</u>	<u>61.34</u>	<u>75</u>	<u>66.95</u>	<u>100</u>	<u>78.56</u>	<u>100</u>	<u>90.66</u>	<u>125</u>	<u>103.05</u>	<u>125</u>	<u>116.11</u>

1. Denotes 100% OA units ONLY, the Maximum CFM for R_80 Recirculation models is 100,000.

2. Denotes 100% OA units ONLY, the Maximum CFM for R_89 Recirculation models is 120,000.

Italic & Underlined Selections Require a Class II Fan.

CF = Consult Factory N/A = Not Available

All BHP's listed include drive losses, Fan performance based on 750 Ft. elevation & 90 F discharge temperature.

ABOVE DATA IS SUBJECT TO CHANGE WITHOUT NOTICE. CONSULT FACTORY FOR SPECIFIC APPLICATIONS

The R-Series

Gas Manifold Sizing & Selection

Burner Output Sizing (Nominal)

Approximate burner output on an R-Series unit is calculated based on the desired CFM capacity and discharge temperature rise: $CFM \times 1.14 \times \text{Temperature Rise } (\Delta T) = BTUH$

Example: 14,000 CFM unit with a 76 ΔT ... $14,000 \times 1.14 \times 76 = 1,212,600$ BTUH (or 1,213 MBH)

Note: Actual BTU capacities will be calculated by AbsolutAire at the time of order, based upon temperature rise and project specifics, using the following formula:

$$BTU = \frac{CFM \times \rho \times C_p \times 60 \times \Delta T}{0.92}$$

ρ = air density at fan C_p = specific heat ΔT = temp. rise

Gas Manifold Sizing

R-Series gas manifolds are sized using the sizing chart, which determines the manifold size based on the inlet gas pressure and calculated burner output. Draw a vertical line from the Burner Output until it intersects any of the manifold size curves, then draw a horizontal line to the left to determine Minimum Gas Pressure. If the vertical line does not intersect a manifold size curve, select the next largest size (to the right).

Example: Gas Pressure = 12.5" WC
 Burner Output = 3,250,000 BTUH
 Select a two-inch (2") manifold

Note: If you cannot get a low enough gas pressure by selecting a larger manifold to meet your project requirements, consult factory for "Low Pressure Alternatives." For inlet gas pressures below 6" WC, consult factory. Pressures above 1 psi (28" WC = 1 psi) are considered 1 psi for manifold sizing and selection.

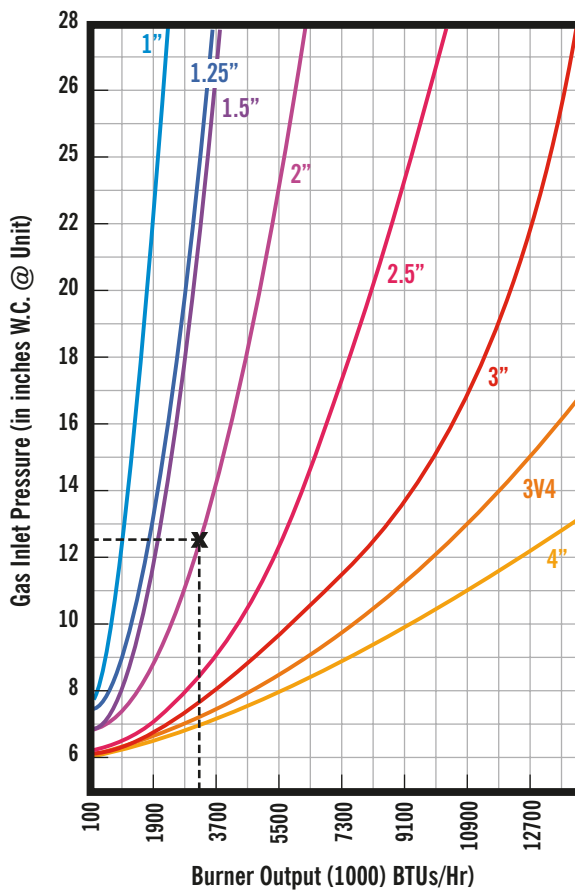

Controls & Special Solutions

R-Series direct-gas-fired systems offer a range of standard and optional control systems and various “special solutions” for selected operating parameters and application challenges.

Standard and Optional Controls

AbsolutAire’s standard control system for R-Series models has a main control panel at the unit and a diagnostic remote control panel in the area being served. This basic failsafe strategy monitors and precisely controls building pressurization and/or space temperature.

Maxitrol Series 14 discharge temperature controls are standard on 100% OA models; Series 44 controls on “F” models. Maxitrol DFM digital space temperature controls are standard on M- and B-type Return Air models. Optional controls include advanced microprocessor systems for networking and total facility air management control.

Note: Refer to AbsolutAire’s “HVAC Monitoring & Control Systems” brochure for further information about our DDC control options.

Special Solutions

AbsolutAire’s innovative and versatile R-series design technology offers almost limitless system configurations. Key operating options include:

Humidification – Direct evaporative media can be used on R-series units for space humidification and area cooling. Grains of moisture are added to the discharge air stream, increasing space humidity content. A cooling effect is achieved by the evaporation of the water from the saturated media, which reduces the dry bulb temperature. Other options for humidification include steam and water atomization.

DX Evaporator Coil or Chilled Water Cooling – Direct expansion (DX) evaporator coils or Chilled Water (CW) coils can be used with AbsolutAire’s standard burner system to provide seasonal cooling. Or, they can be used alone for cooling only.

Hot Water and Steam Heating – Hot water coils and steam coils can be used for heat generation, especially in facilities having ample process heat or boiler systems. Such coils can replace the burner system, or be included with a burner to provide fuel flexibility and operating choices.

Electric Coil Heating – In some applications, where electricity is plentiful and relatively inexpensive, electric resistance heating coils may be used. Today’s high-efficiency coils are available in a range of kilowatt capacities, complete with safety devices such as fusing, airflow switches and high-limit thermal cutouts.

Note: Refer to AbsolutAire’s “Commitment to Meeting Special Challenges” brochure for further information about special solutions.



Evaporative Media

The R-Series

Dimensional Data

Horizontal Cabinets

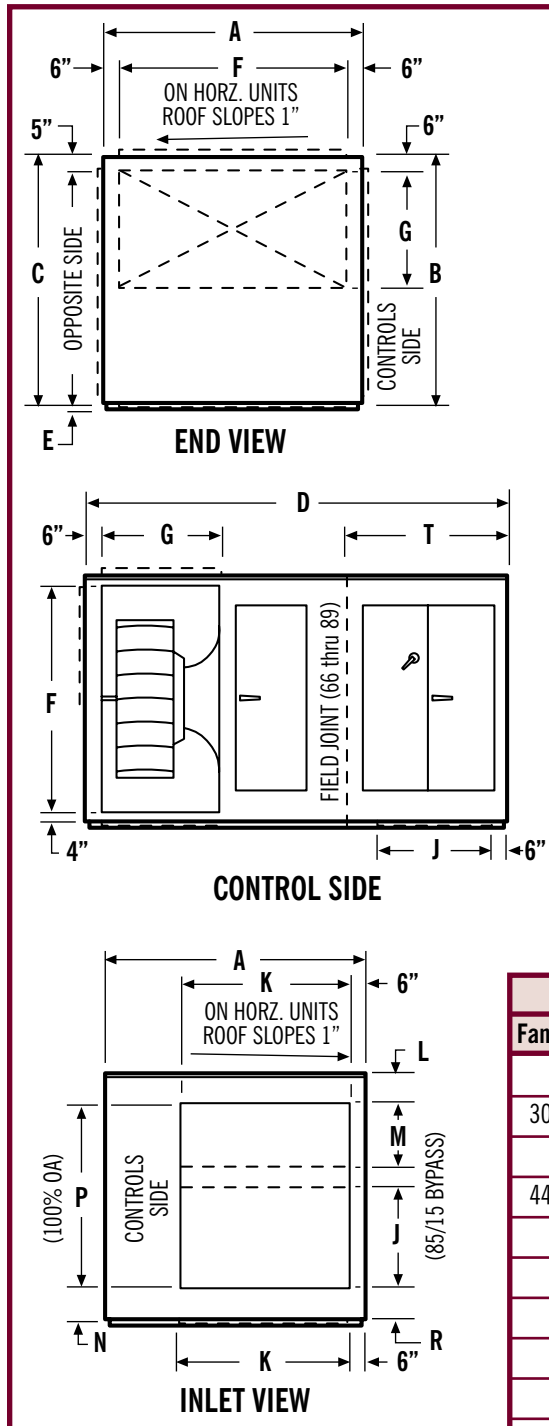

Upright Cabinets

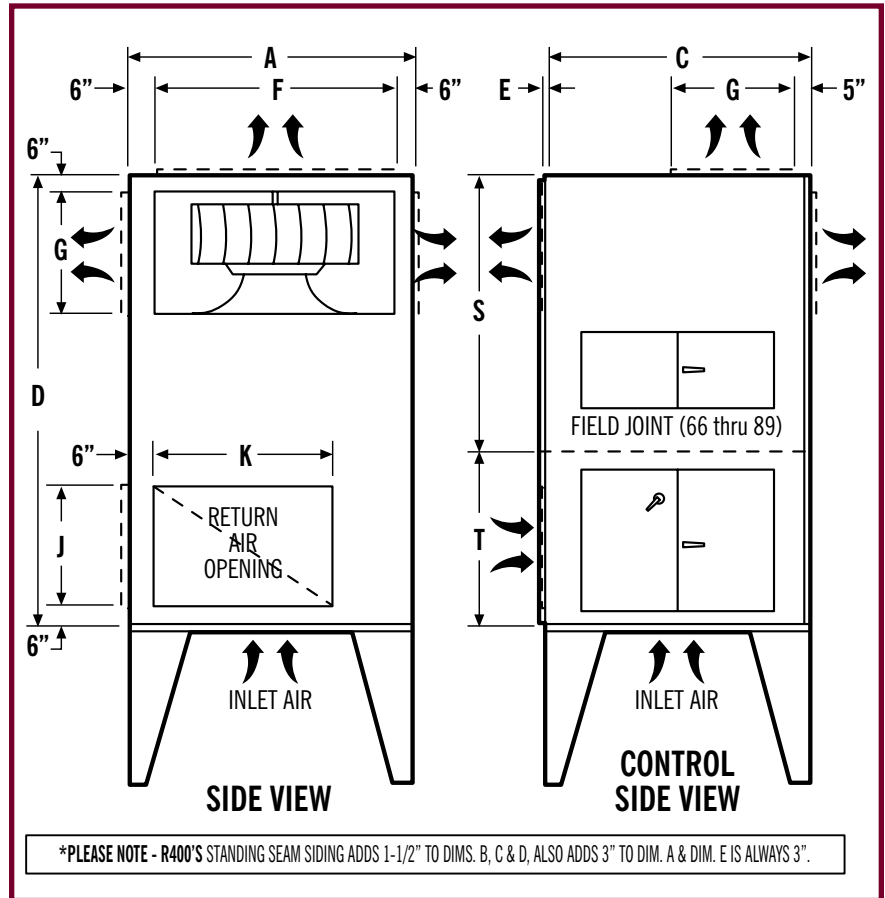

R300 & R400 Series Cabinet Dimensional Data, Inches															
Fan Size(s)	A	B	C	D	E	F	G	J	K	L	M	N	P	R	T
27	56	53	52	118	2	44	24	27	34	6	5	10	32	7	-
30 & 36	66	63	62	126	2	54	30	34	44	7	6	9	44	7	-
40	74	71	70	130	2	62	35	44	48	5	8	9	52	8	-
44 & 49	84	81	80	140	2	72	40	49	58	7	9	9	62	8	-
54	92	89	88	153	3	80	46	54	64	6	10	9	70	8	-
60	98	95	94	160	3	86	48	60	70	8	11	8	78	8	-
66	107	104	103	180	3	95	55	68	79	7	12	9	85	9	100
73	118	115	114	180	3	106	55	68	90	11	12	9	96	9	100
80	128	125	124	200	3	116	62	68	98	13	12	8	108	12	120
89	135	132	131	214	3	123	70	74	105	13	13	8	115	12	128

NOTE: All dimensions are subject to change without notice.

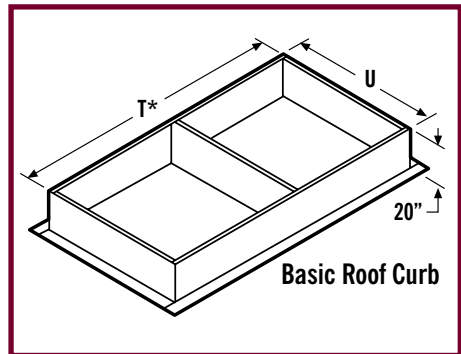
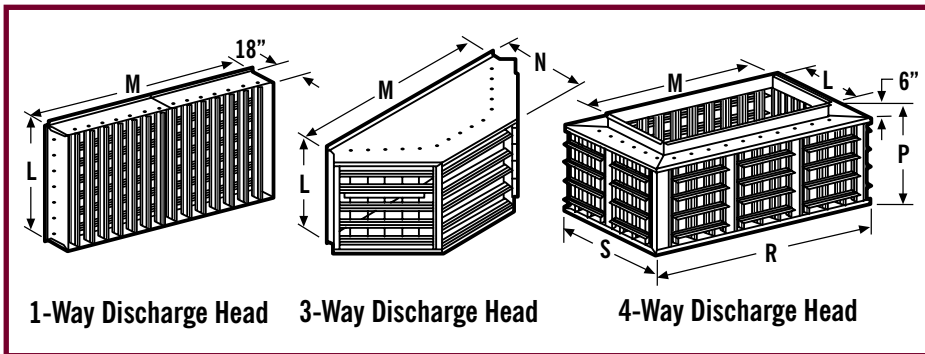
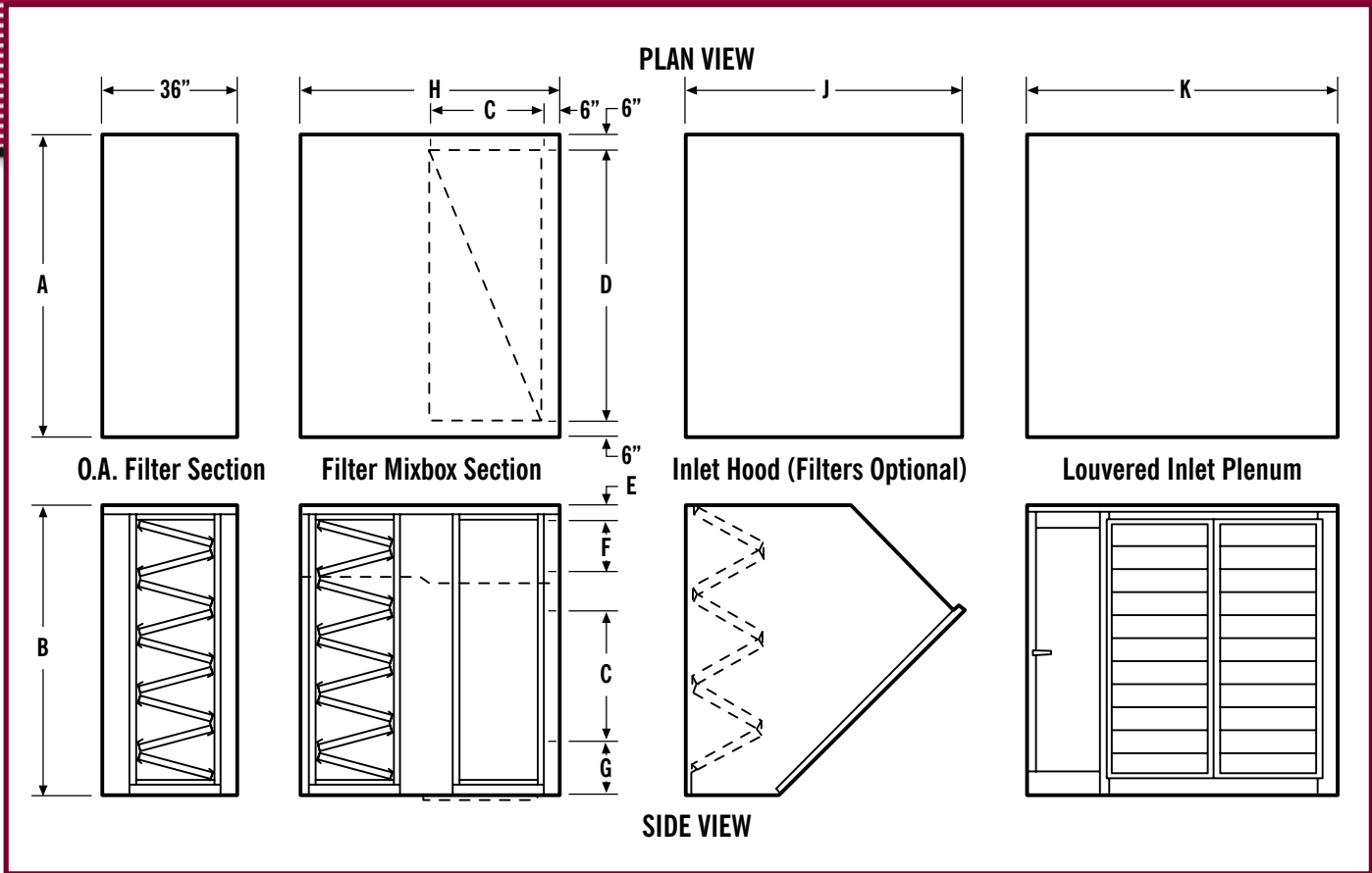

Options & Accessories

R300 & R400 Series Option and Accessory Dimensional Data, Inches																		
Fan Size(s)	A	B	C	D	E	F	G	H	J	K	L	M	N	P	R	S	T*	U
27	56	53	23	44	7	5	7	59	74	68	24	44	28 1/8	22 1/8	71	51	113	51
30 & 36	66	63	30	54	7	5	9	66	74	76	30	54	31	28 1/8	81	57	121	61
40	74	71	34	62	8	6	13	70	74	82	35	62	33 3/8	32 1/8	89	62	125	69
44 & 49	84	81	40	72	9	7	11	76	84	88	40	72	36 1/4	36 1/8	99	67	135	79
54	92	89	44	80	8	8	12	80	98	92	46	80	38 5/8	40 1/8	107	73	148	87
60	98	95	49	86	8	9	11	85	98	100	48	86	40 3/8	44 1/8	113	75	155	93
66	107	104	57	95	8	10	11	93	98	106	55	95	43	46 1/8	122	82	175	102
73	118	115	58	106	8	10	13	94	98	108	55	106	46 1/4	52 1/8	133	82	175	113
80	128	125	58	116	9	10	13	94	110	108	62	116	49 1/8	54 1/8	143	89	195	123
89	135	132	64	123	9	11	15	100	110	132	70	123	51 1/4	57 1/8	150	97	209	130



*Dimensions shown are for basic curb only - consult factory for curb size if options (mixbox, louver plenum, etc.) are added to unit.

NOTE: All dimensions are subject to change without notice.

The R-Series

General Specifications

Furnish and install a direct-gas-fired make-up air or heating and ventilating unit including all components as shown on plans. The unit shall be completely factory assembled by AbsolutAire and wired in accordance with the National Electric Code (NEC) and NFPA 70. The unit shall include:

- A.** Blower mounted downstream of the burner to insure a constant volume of discharge air, regardless of inlet air temperature. Blower shall be a single-width, single-inlet (SWSI) backward inclined airfoil plenum type with spherical roller bearings and solid steel shaft. Fans are statically and dynamically balanced.
- B.** Cabinetry shall be fabricated of 16-gauge steel fully welded (R300 models) or 18-gauge aluminized steel with standing-seam construction (R400 models). Housing shall have gray oxide-primed structural steel framing members (R300 models) or gray oxide-primed tubular steel framing members (R400 models). Access doors shall be provided for control enclosures and service areas. Intake filter racks shall be of the easy-access type, requiring no tools for removal of the filters.
- C.** A motorized inlet-air shut-off damper and all operating controls shall be provided.
- D.** The supply air fan, blower motor and the direct-gas-fired heating compartment shall be completely installed.
- E.** The unit interior shall be provided with one-inch-thick, 1-1/2# density fiberglass insulation (R300 models) or two-inch-thick, 3# density fiberglass insulation (R400 models).
- F.** All exterior surfaces shall be treated with a two-coat machine enamel paint finishing process. Owner-selected colors shall be provided at no additional cost.
- G.** Provide a factory-wired master control panel mounted in a weather-resistant enclosure. The panel shall include a magnetic motor starter or contactor and overload relay, fused control transformer, terminal strip, heat relay, and high and low temperature limit switches. All controls shall be pre-wired to a factory-installed, through-door, fused disconnect.
- H.** Provide all gas controls including control switch, circuit fuse, flame safeguard relay, ignition transformer, electric solenoid gas valve, modulating gas valve with a 30:1 turndown ratio capability, gas pressure regulators, and high and low air-pressure differential switches. All gas controls shall be mounted inside the control enclosure behind an easy-access service panel.

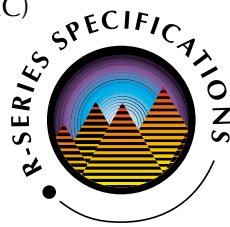

R300 Upright Model

- I.** Provide a burner, fabricated of stainless-steel mixing plates and a heavy-duty cast-iron manifold (cast aluminum available). Ignition of the pilot shall take place through the use of a spark igniter and verified through the flame-safeguard system.
- J.** Provide a rigid mount, ball bearing type, open drip proof, EPACT-compliant fan motor, suitable for the specified voltage. Motor to be mounted on an adjustable base for belt tensioning.



R400 Horizontal Model

Quality Control and Warranty Services

R-Series direct-gas-fired systems are built to exacting standards for long-lasting performance and exceptional operating economy. As a result, these environmentally friendly, high-value solutions are the unquestioned standard for excellence in direct-fired design technology.



AbsolutAire is firmly committed to providing customers with total value. That means more than simply bringing together design innovation with unsurpassed construction integrity. Stringent in-plant quality-control checks are matched with expert installation guidelines and timely equipment start-ups. An extensive inventory of replacement parts is ready should the need arise. A quick-response, factory-authorized service network is dedicated to making sure the equipment performs as designed. All of this is backed by AbsolutAire's exclusive Two-Year Parts and 90-Day Labor Limited Warranty.

Pure and Simple: Meeting and exceeding your expectations is our **only** way of doing business. Your complete satisfaction on product, process and commitment is our Number One priority.

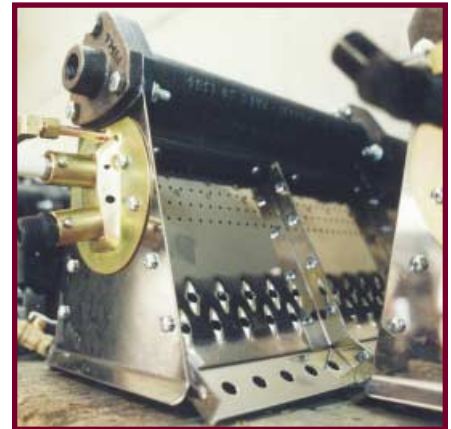

The AbsolutAire Two-Year Limited Warranty

Parts furnished by AbsolutAire that prove to be defective at the site of the original installation within **24 months from the date of start-up, or 27 months from the date of shipment, whichever comes first, will be replaced or repaired at AbsolutAire's discretion. Wear items, such as V-belts, filters, etc., are not included as covered parts under this Warranty.** Defective parts must be returned to AbsolutAire at the customer's expense. Warranty replacement parts will be shipped freight prepaid from AbsolutAire via normal ground service.

The customer must notify AbsolutAire promptly in writing of any claim under this Limited Warranty. AbsolutAire will require information to ensure the equipment has been installed and maintained properly, and operated as intended within the specifications as stated on the AbsolutAire Quotation and/or Order Acknowledgment. Components provided by others are not covered under this Warranty. If an AbsolutAire part fails as a result of components furnished by others, the AbsolutAire component may not be covered under this Warranty.

Reimbursement for labor to remove and/or install replacement parts is included in this Warranty for a period of 30 days from field start-up or 90 days from shipment, whichever comes first. AbsolutAire is responsible to determine the amount of labor reimbursement allowed, based upon the circumstances for each installation. Labor cost reimbursement must be approved by AbsolutAire **prior** to work being performed.

Disclaimer: The warranties contained in this written Limited Warranty are made in lieu of all other warranties expressed or implied, statutory or otherwise. In particular, AbsolutAire makes no warranty of merchantability for fitness for a particular purpose, unless written and signed by an officer of the Company referencing this particular disclaimer. AbsolutAire shall have no liability to the customer/owner for direct, consequential or incidental damages of any kind whatsoever.

The R-Series

Features, Options, Accessories

Standard Feature Descriptions

Maxitrol Temperature Controls: Series 14 discharge temperature controls are standard on 100% Outside Air models, while Series 44 discharge temperature controls are standard on F-Option models. DFM digital space temperature controls are standard on M- and B-type Return Air models. The burner modulates up and down (30:1 turndown) to satisfy the temperature set point (selected at the remote control panel).

Damper Motor End Switch: An end switch prevents fan and burner operation before the damper is in its full-open position. This switch is standard on Return Air models.

Remote Flame Relay Reset: This provides the capability to reset the flame relay at the remote control panel.

Solid-State Flame Safeguard System: The ultraviolet (UV) sensing system proves pilot and monitors main flame to ensure equipment safety and reliability.

Mechanical Options and Accessories*

Motorized Inlet Damper: A 16-gauge galvanized steel damper can be provided. The damper will be driven by a two-position damper motor on 100% Outside Air models. On Return Air models, the OA modulating dampers will close upon unit shutdown and act as inlet dampers. Low-leak damper options, with blade and jamb seals, are also available.

Inlet Hood with Bird Screen: This inlet hood is designed to minimize the ingestion of moisture, birds and possible airborne refuse.

Inlet Hood with Bird 2" Aluminum Filters: This hood has two-inch aluminum filters (in lieu of a bird screen) for additional protection against the ingestion of moisture and airborne contaminants.

Louvered Inlet Plenum: This type of inlet plenum lowers the inlet air velocity, reducing moisture ingestion. (Recommended for units over 60,000 CFM.)

Outside Air (OA) V-Bank Filter Housing: This filter housing would be mounted on the OA inlet of the unit. It can be provided with a variety of two-inch (2") filtering media options.

Mix Box Filter Section: Available for RA models, allowing the filtration of both outside air and return air. It can be provided with a variety of two-inch (2") filtering media options.

Splash Plate: A splash plate can be provided for economical re-direction of the air flow on down-discharge rooftop units.

Discharge Diffusers: Three-way, four-way and one-way discharge diffuser heads are available. Directional airflow control options include single- or double-deflection blades.

Insulation: One-inch (1") thick, 1.5# density neoprene-coated fiberglass insulation, glued and weld-pin fastened, can be added to R300 models. Two-inch (2") thick fiberglass insulation can be added to R400 models. Either can be sandwiched between double-wall construction. One-inch foil-faced fiberglass insulation is also available with 1.5# density.

Service Platform: A service platform can be provided with a ladder and handrails to meet OSHA requirements.

Support Legs, Any Length: Sturdy 10-gauge galvanized steel, enamel-painted support legs can be provided for all models.

Roof Curb: A reinforced, aluminized steel roof curb provides for horizontal unit support.

Suspension Vibration Isolation: Elastomer in-shear or spring-type vibration isolators, properly sized for the weight of the entire unit, can be provided for curb, post or suspended horizontal units.

Exhaust Cycle: The addition of a discharge damper and controls facilitates operation of the supply air unit as an exhaust air unit when certain conditions exist (pressure, CO, CO₂, smoke or other).

Evaporative Cooling: Evaporative media helps to control space humidity and provide occupant cooling and comfort.

Heating Coils: Steam, Hot Water (HW) or Electric Resistance coils can be used with the direct gas fired burner or sized to replace it.

Cooling Coils: Chilled Water (CW) or Direct Expansion (DX) coils can be provided to add seasonal cooling to the unit.

High-Efficiency Filtering: Various bag and cartridge filters, with 65% to 95% efficiencies, can be provided. HEPA filters are also available. Consult factory for specific details.

Electrical Control Options and Accessories*

TEFC EPACT Motors: The blower-motor will be 1800 rpm, totally enclosed, and fan-cooled. The motor will have a T-frame, a minimum service factor of 1.15, and an adjustable slide base. The motor voltage rating will be specific to the application. Motors are available in standard or premium efficiency ratings. Also, Corro-duty, explosion-proof and 7E-TA (automotive spec) motors are available.

Electronic Time Clock: A 24-hour, 7-day time clock allows automatic operation of the unit. The control sequence is user defined.

DDC Microprocessor Temperature Controls: With the addition of microprocessor controls, each unit can be operated “stand-alone” or networked to a centrally located PC and/or modem. Various control systems are available. These controls provide the user with maximum flexibility in system operation, hardware configurations, software design and warranty.

Damper Control for Modulating (M-type) By-Pass Models: A building pressure switch is provided as standard equipment to control the blend of outside air and return air. The dampers modulate when more outside air is needed to maintain the slight positive pressure in the space. These controls can be provided with a manual override switch at the remote panel, interconnected with a time clock or other features.

Mild Weather Stat:

An outdoor thermostat is provided to automatically de-energize the burner when the outdoor air temperature reaches a certain, adjustable set point. The burner is re-energized when the outside air temperature drops below that set point.

Burner Alarm Horn: This alert horn sounds whenever the burner loses flame in the heating mode.

Purge Timer, 30-Seconds: This increases the purge time from the standard R-Series time of 15 seconds.

Three-Phase Power Monitor: This device activates upon phase loss or single-phasing, and it disengages the power supply from the fan motor preventing motor winding damage.

Smoke Detector: This option can be user-installed in the supply air or return air ductwork, or unit-installed at the factory. It can be provided to interface with other system indicators and alarms, as needed.

Access Door Interlock: This switch activates upon the opening of the fan section access door and interrupts power to the fan motor.

120V GFI Outlet and Light: R-Series models are equipped with standard 120V lighting in the recessed electrical and gas controls enclosures. This option adds a 15-amp GFI service outlet in the electrical enclosure.

Dirty (Clogged) Filter Indicator/Alarm: A pressure-sensing switch is used to monitor airflow filtering. The switch will energize a warning light (and/or alarm) when the filters need maintenance. This switch can be provided with a magnahelic gauge.



Magnahelic Gauge: This type of gauge can be provided for certain user-specified control needs.

Photohelic Gauge: This type of gauge can be provided in lieu of a building pressure switch to allow more finite adjustments.

CO Detector: This detector allows a single- or dual-level CO set point. When the set point is reached, the device activates various control options such as outside or return air dampers, exhaust dampers, etc.

Gas Control Options and Accessories*

FM/IRI Gas Manifold: The gas manifold will be built in accordance with the requirements set forth by Factory Mutual/Industrial Risk Insurers.

Natural Gas/Propane (LP) Changeover Switch: This switch at the remote panel allows the user to change from a natural gas supply to a propane gas supply. It includes a special gas valve.

High Gas Pressure Regulator: A full lock-up regulator, with internal relief, is provided to allow reducing the unit gas supply pressure when inlet pressures are greater than 5 psi.

Low Gas Pressure Burner: When gas supply pressure at the unit is at or below 10" WC, and at or more than 6" WC, a low-gas-pressure burner assembly may be provided. This will depend on the specific gas pressure and the MBH requirements. This alternate burner will be provided at no additional cost to the customer.

*Consult Factory for Options Not Listed.

The R-Series

Meeting & Exceeding Customer Expectations

R-series direct-gas-fired systems for make-up air and heating and ventilating deliver outstanding performance, as well as exceptional operating economies. With its track record of success, AbsolutAire has built the foundation for even greater accomplishments in the future. A partial list of our satisfied customers includes ...

American National Can
American Seating
Anheuser Busch, Inc.
Appleton Papers
Benteler Industries
Best Buy
Bradford White
Coca Cola
Dana Corporation
John Deere
Federal Mogul
Ford Motor Company
General Motors
Gerber Products
Haworth, Inc.
HON Company
Johnson Controls, Inc.
Kimberly Clark
Maytag

Meijer
Pepsi, Inc.
Polaris Industries
Quaker Oats
Reynolds Metals
Sam's Club
Sears
Steelcase, Inc.
Target Distribution
Toyota Motor Co.
True Manufacturing
United Technologies
United Parcel Service
Wapauca Foundries
Wolverine World Wide
Yale Material Handling





Other *Pure and Simple Solutions:*

- ▲ S-Series Air Handling Systems
- ▲ AA-Series Direct-Fired Heating & Ventilating
- ▲ EV-Series Evaporative Cooling Systems
- ▲ DH-Series Door and Construction Heaters



Represented by:



5496 North Riverview Drive • Kalamazoo, MI 49004
Phone: (800) 804-4000 • Fax: (269) 382-5291

www.absolutaire.com